



KINEVO 900 from ZEISS
Advancing Surgical Certainty



Mastering the complex.

ZEISS KINEVO 900

KINEVO 900 – The Robotic Visualization System

Just like you, we love challenging the status quo.

The result? Over 100 innovations to perfect the already acclaimed surgical visualization platform. KINEVO® 900 from ZEISS is designed to deliver more functionalities than any surgical microscope today.

ZEISS KINEVO 900 combines **digital and optical visualization modalities**, offers a unique **Micro-Inspection Tool** and will impress you with its **Surgeon-Controlled Robotics**. All to enable you to gain greater certainty in a virtually disruption-free workflow.

Designed to meet real needs. To make a real difference!

// INNOVATION
MADE BY ZEISS

A lot more. And, a lot less too.

When treating complex vascular conditions, you typically work at high magnification. Even the slightest vibrations can cause disruptions. And constant manual repositioning to better visualize structures or precisely approach deep-seated lesions can become extremely tedious. Not anymore! ZEISS KINEVO 900 delivers a lot more positioning precision with a lot less effort.

PointLock

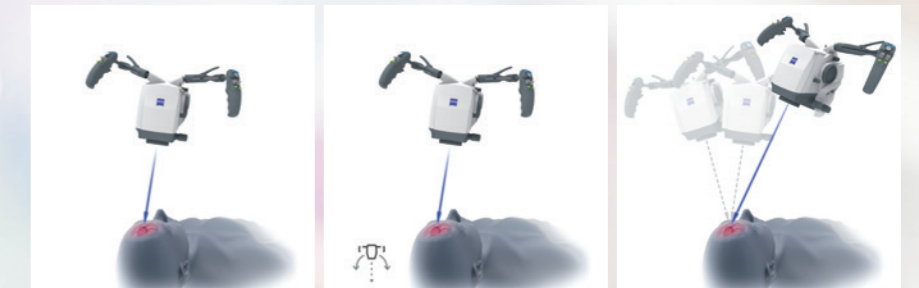

Focus

Activate

Swivel

Surgeon-Controlled Robotics adds a complete new level of ease to precise positioning. Imagine being able to focus and move around a structure to visualize the targeted anatomy – reducing any manual hassle. In addition, **PointLock** enables you to do a KeyHole movement to observe a larger area inside a cavity – a particular benefit in areas with narrow access. Simply put:

Focus. Activate. Swivel.

Active vibration dampening



You know the problems that can be created by the tiniest vibrations. The active dampening provided by ZEISS KINEVO 900 minimizes collateral system vibrations, ensuring rock-solid stability. Enabling you to completely, and steadily, focus on what matters most: **your treatment.**



When you need it. Where you need it.

The new navigation interface of ZEISS KINEVO 900 is designed to work in concert with your navigation device. When you require precise repositioning to reexamine previously visualized structures or when you need to align with a pre-mapped trajectory, making use of all six axes, the **Robotic Visualization System™** delivers precise positioning at the push of a button. Putting you exactly where you need to be – when you need to be there.

PositionMemory

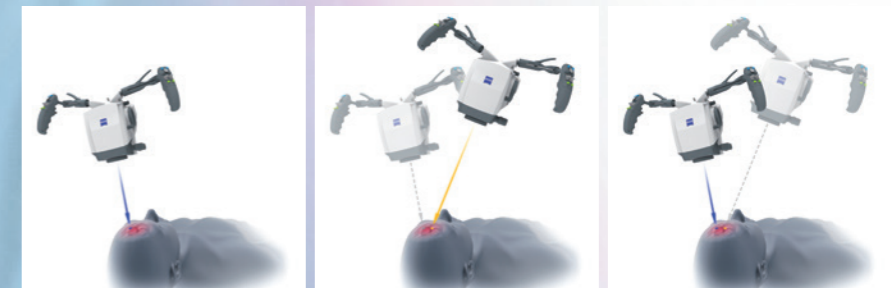

Save

Move

Recall

When working on a tumor case, you may already have identified regions of concern where you want to protect the functional structure. After storing these in **PositionMemory**, you can come back and visualize them at the exact same magnification, working distance and focus – without losing time for manual repositioning. In a nutshell: **Save. Move. Recall.**

Image-guided surgery

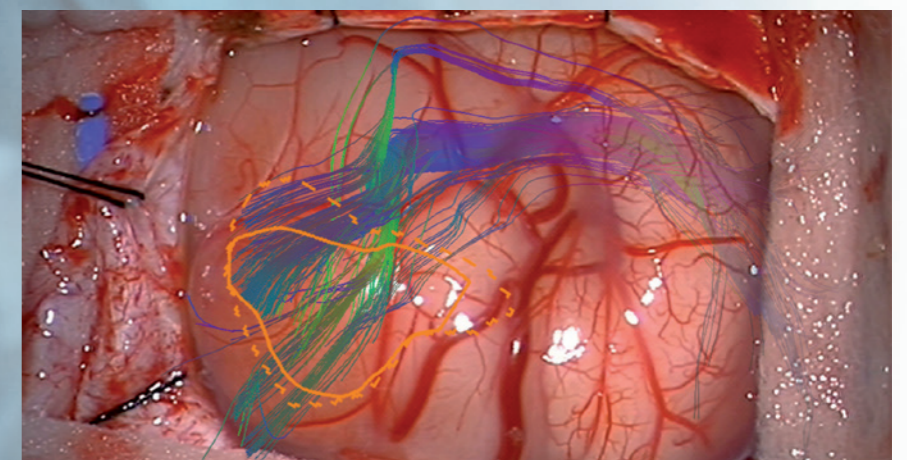

Approaching deep-seated pathologies in cranial surgery, such as aneurysms, brain stem and skull base tumors, is challenging. The **Surgeon-Controlled Robotics** of ZEISS KINEVO 900 enables automated positioning to pre-defined anatomical landmarks based on pre-operative data planning – **right when you need it.**



Critical challenge. Vital solution.

Your challenge: When working from an external perspective of a surgical microscope, your visualization of the anatomy is limited to a straight line of sight – missing critical information behind tissue or corners. Efficient and effortless access to this comprehensive information is essential for treatment.

Our solution: **QEVO® from ZEISS**

The unique, proprietary **Micro-Inspection Tool** from ZEISS complements intraoperative microsurgical visualization, enabling you to discover unexplored areas during the surgical intervention without additional footprint. You can look around corners and eliminate blind spots. And most importantly, you can gain greater insights – for better clinical decisions.

To support your surgical workflow, ZEISS QEVO* is engineered with an angled design – keeping your hands out of the line of sight during insertion in the surgical field. And, it allows for an easy fit between the ZEISS KINEVO 900 and the situs, eliminating the need to reposition the head of the device.

Greater insights, on demand.

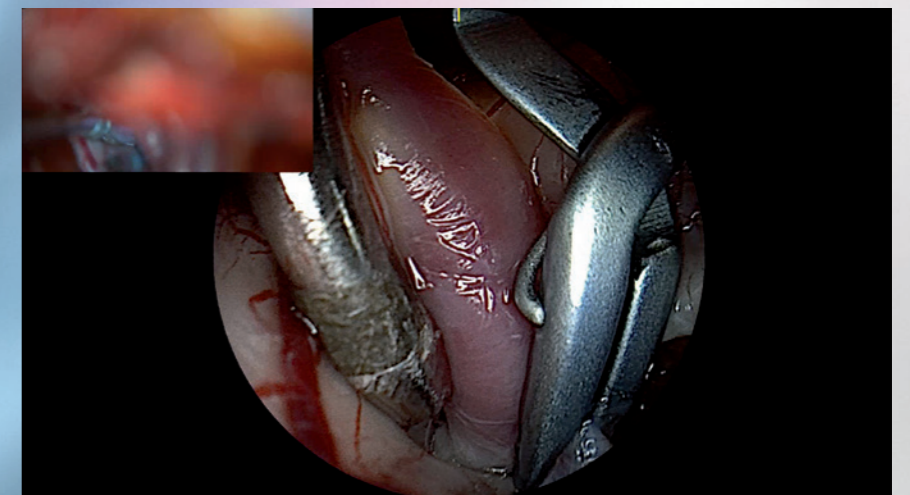

ZEISS QEVO enables you to inspect the perforator or examine the distal neck of the aneurysm to ensure the clip blades are fully extended.

*510(k) pending. Not for sale in the USA. Not available in all markets.



Ease of use. Peace of mind.

Surgical certainty is your imperative. Enabling you to achieve it is ours. That's why, in the development of the Micro-Inspection Tool, we placed a high priority on its ease of use.

ZEISS QEVO* is truly integrated. You don't have to plan for an additional device during surgery. Just plug it into your ZEISS KINEVO 900 for a seamless surgical workflow and to easily switch back and forth between views.

ZEISS QEVO is fully autoclavable. So there's no need for any additional draping. This is another attribute that makes ZEISS QEVO an indispensable tool – always available during surgery. On demand.

ZEISS QEVO. Innovation in action.

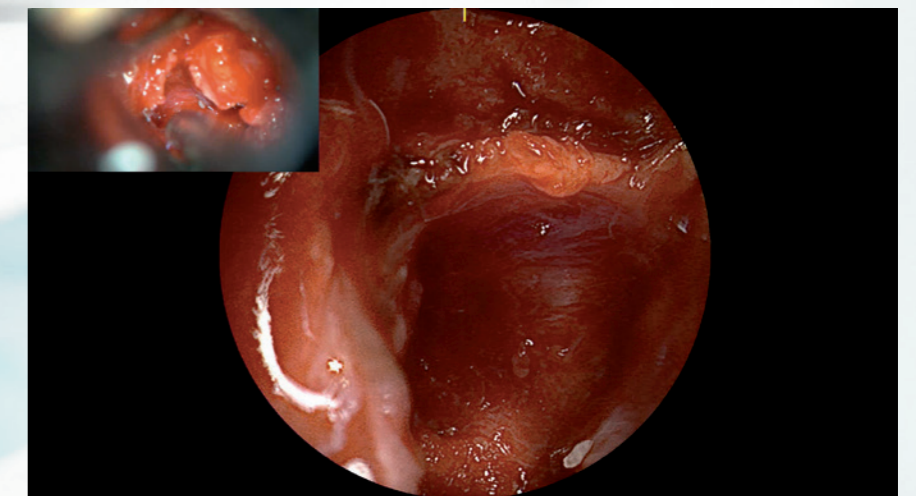

ZEISS KINEVO 900 can support discerning regions that are not directly visualized – avoiding unnecessary bone removal and retraction. During a Vestibular Schwannoma case, for instance, it can help identify the course of facial nerves. And, can support inspection of regions that are not directly visualized by a surgical microscope.

*510(k) pending. Not for sale in the USA. Not available in all markets.



New dimensions. Freedom of choice.

Working through oculars at extreme angles can sometimes be a pain in the neck. Literally. With no way out, you might have to contend with uncomfortable working positions causing fatigue. Now, relief and revolutionary dimensions in visualization are in sight.

The **Digital Hybrid Visualization** with integrated 4K technology of ZEISS KINEVO 900 welcomes you to a world of heads-up ocular-free surgery, giving you freedom of movement. And freedom of choice to use an optical setup, depending on the application need.

Fully integrated 4K camera technology

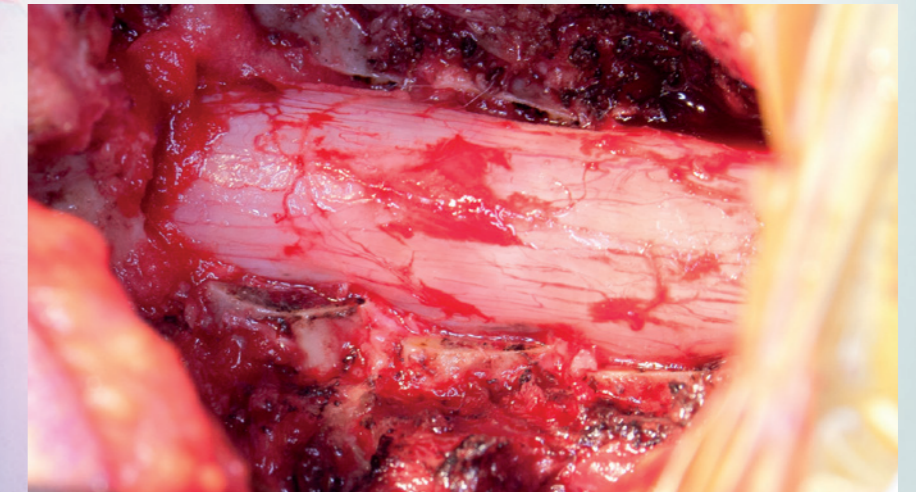

During lateral lumbar or thoracic spine and posterior fossa approaches, ZEISS KINEVO 900's integrated 4K visualization can be essential. It provides you with multimodal visualization capabilities – the flexibility to decouple from the classic optical approach and to work with outstanding 4K picture quality and clarity. Even when magnifying tiny details.

What's more... your assistant surgeon, OR staff and residents also benefit from the 4K visual clarity of ZEISS KINEVO 900. They share the same high-resolution, digital image to follow the procedure with comparable fidelity. Delivering indispensable education and training.

Deeper insights. Greater control.

Imagine being able to identify the blood flow in the tiniest blood vessels with an intraoperative angiogram during any vascular procedure. Or to analyze the blood flow dynamics in real time. Or to visualize fluorescence-stained structures while viewing the anatomy in natural-like colors. Or, all of the above with one system!

In challenging neurosurgery, visualization adjuncts are essential for making the right decisions at the right time. The redesigned Intraoperative Fluorescence Technologies from ZEISS offer you the **Power of Four** – so you are always equipped with the tools you need. **Check. Interpret. Decide.**

ZEISS INFRARED 800 – Now in HD resolution

Intraoperative visual assessment of blood flow and vessel patency during aneurysm, bypass and AVM surgery is critical to your treatment. During such complex vascular procedures, the new high definition visual quality of ZEISS INFRARED 800 enables visualization of sub-millimeter blood vessels – for deeper insights into the blood flow dynamics.

Before (SD resolution)



After (HD resolution)

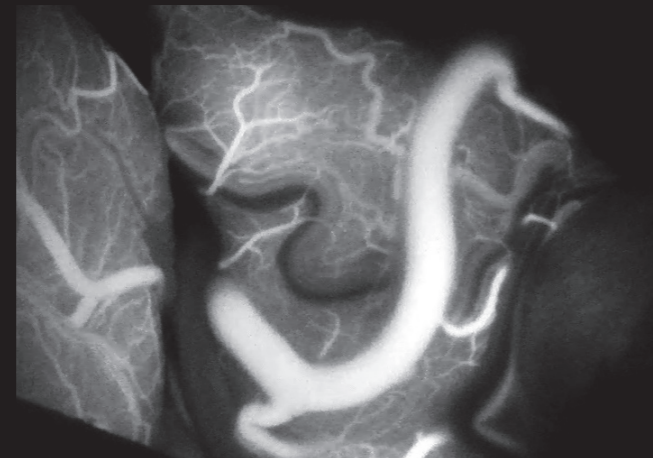

Virtually uninterrupted focus. Always.

ZEISS KINEVO 900 optimizes the workflow to deliver a live overlay of the ZEISS INFRARED 800 image in the oculars – for a virtually uninterrupted workflow.

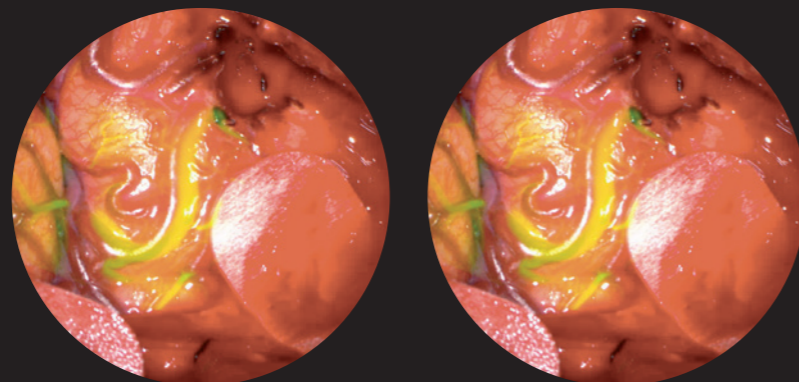

ZEISS FLOW 800

FLOW® 800 from ZEISS is a unique analysis tool generating blood flow dynamics data by identifying detailed vessel blood flow from INFRARED 800 video sequences – intraoperatively. The newly transformed ZEISS FLOW 800 delivers a more convenient visual assessment of the increase in the fluorescence intensity during the procedure.

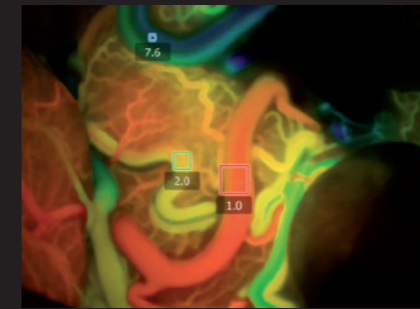

For the indicative time: The Delay Map (or Summary Map) provides quick information about the time when the fluorescent signal appeared for each image point in the map.

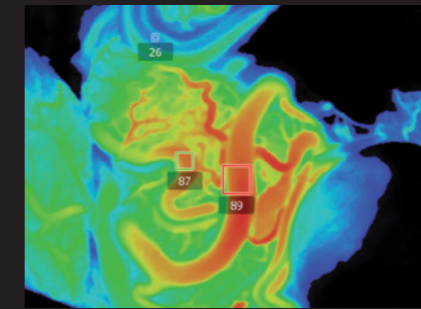

For the fluorescence distribution: The Intensity Map enables you to conveniently identify relative fluorescence levels reached during the INFRARED 800 observation period.

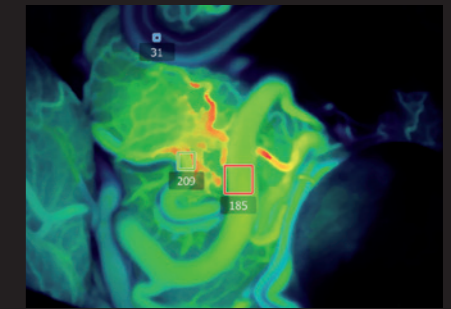

For the speed of the flow: The Speed Map indicates how fast the fluorescence intensity increased during the observation period – indicating the speed of the blood flow.

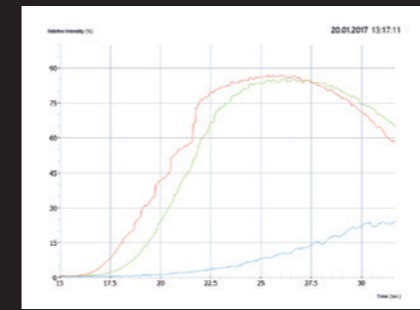

For a complete picture: The Diagram Function outlines assessment of fluorescence intensity variation over time and fast access to the key indicators for further analysis.

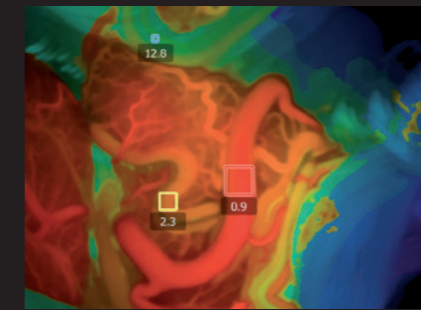

For no compromises: The new optimized view option enables you to generate summaries from a selected sequence of the INFRARED 800 video. For instance, removing video sequences with movement artefact, you can now generate a summary map without compromises. So, you can get the most vivid and helpful representation of your procedure – for the right decisions and convincing podium talks.

ZEISS BLUE 400¹

Capable of supporting fluorescence-based surgery for research applications by providing visualization in the 620–710 nm range in HD quality.



Image obtained with investigational new drug within the scope of a clinical investigation.

ZEISS YELLOW 560¹

Visualizes green-yellowish fluorescence for additional fields of research application. It is the first intraoperative fluorescence module to highlight the fluorescence-stained structures while visualizing non-stained tissue in its natural-like color.

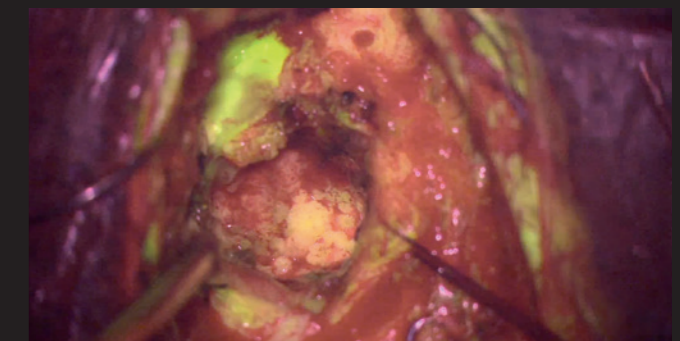

Visualization of fluorescence-stained structures using YELLOW 560. Image obtained with drug under investigation for new intended use within the scope of a clinical investigation.

Setting new benchmarks. Shaping a new future.

When we envisioned the all-new **Robotic Visualization System**, we conceived a design that can deliver so much more without losing its familiarity. With ZEISS KINEVO 900, we continue to live our vision of supporting you in becoming one with your visualization system – of delivering purposeful innovations.

Among scores of leading-edge innovations , here are the ones that matter the most for you.

The Robotic Visualization System: The first of its kind.

Surgeon-Controlled Robotics

Delivering precise positioning with a lot less effort – with motors in all axes.

ZEISS QEVO¹ – The Micro-Inspection Tool

Complementing intraoperative microsurgical visualization to discover unexplored areas during surgical intervention. Gain greater insight. On demand.

ZEISS Observe² – Live stream in real time with ZEISS VR ONE Plus.

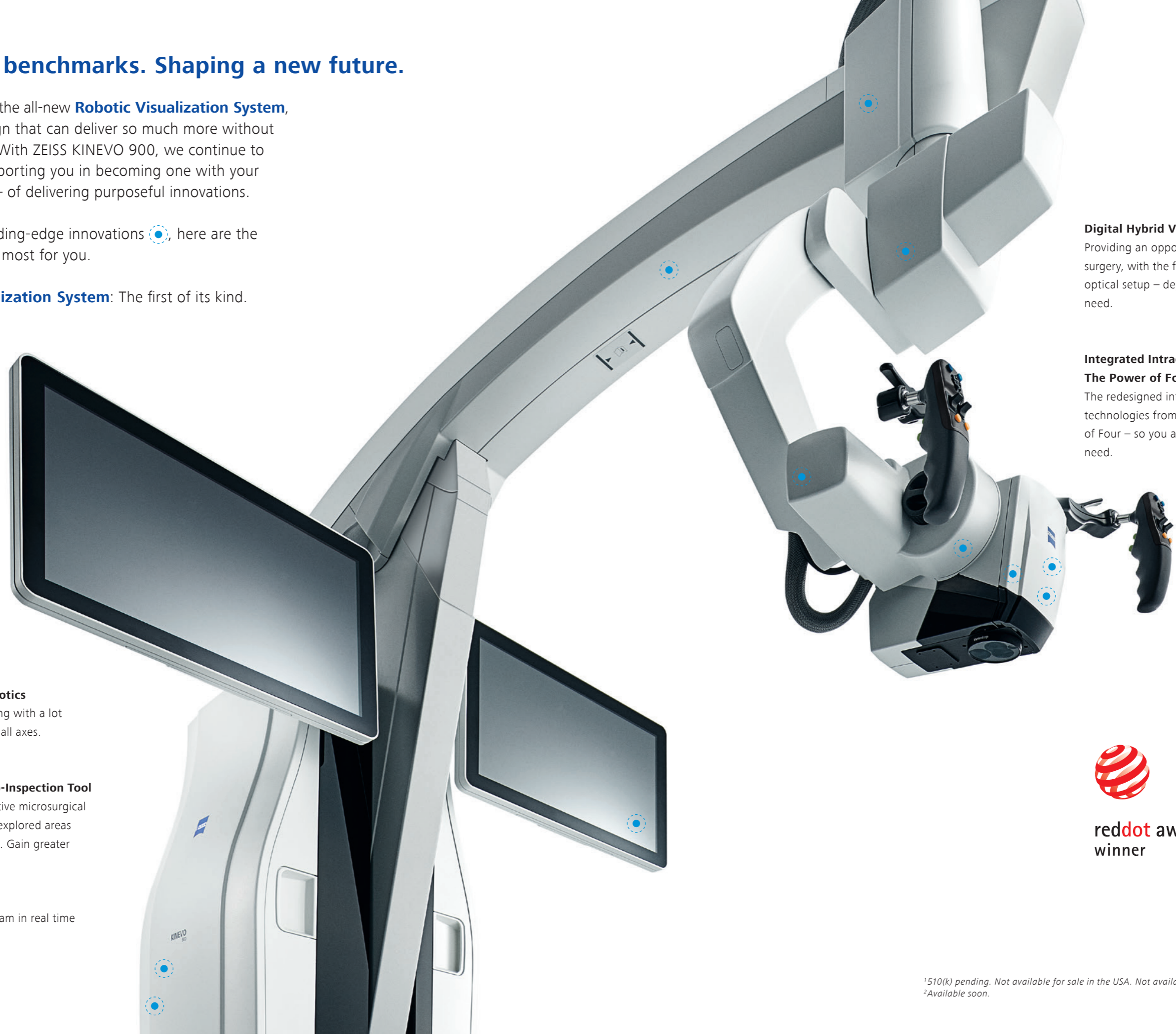

Digital Hybrid Visualization

Providing an opportunity for ocular-free surgery, with the freedom to use a traditional optical setup – depending on the application need.

Integrated Intraoperative Fluorescence – The Power of Four.

The redesigned intraoperative fluorescence technologies from ZEISS offer you the Power of Four – so you always have the tools you need.



red dot award 2017
winner

Technical Data

KINEVO® 900 from ZEISS

Technical Data	
Rated Voltage	100 V – 240 V
Current	Max. 1.350 VA
Consumption	
Rated Frequency	50 Hz – 60 Hz
Electrical Standard	Complying with IEC 60601-1:2005+A1:2012 Protection class I, degree of protection IP20 Class 2 laser product as per IEC 60825:2007, IEC 60825:2014
Weight	Weight max. 365 kg Weight of system incl. transport container: approx. 510 kg

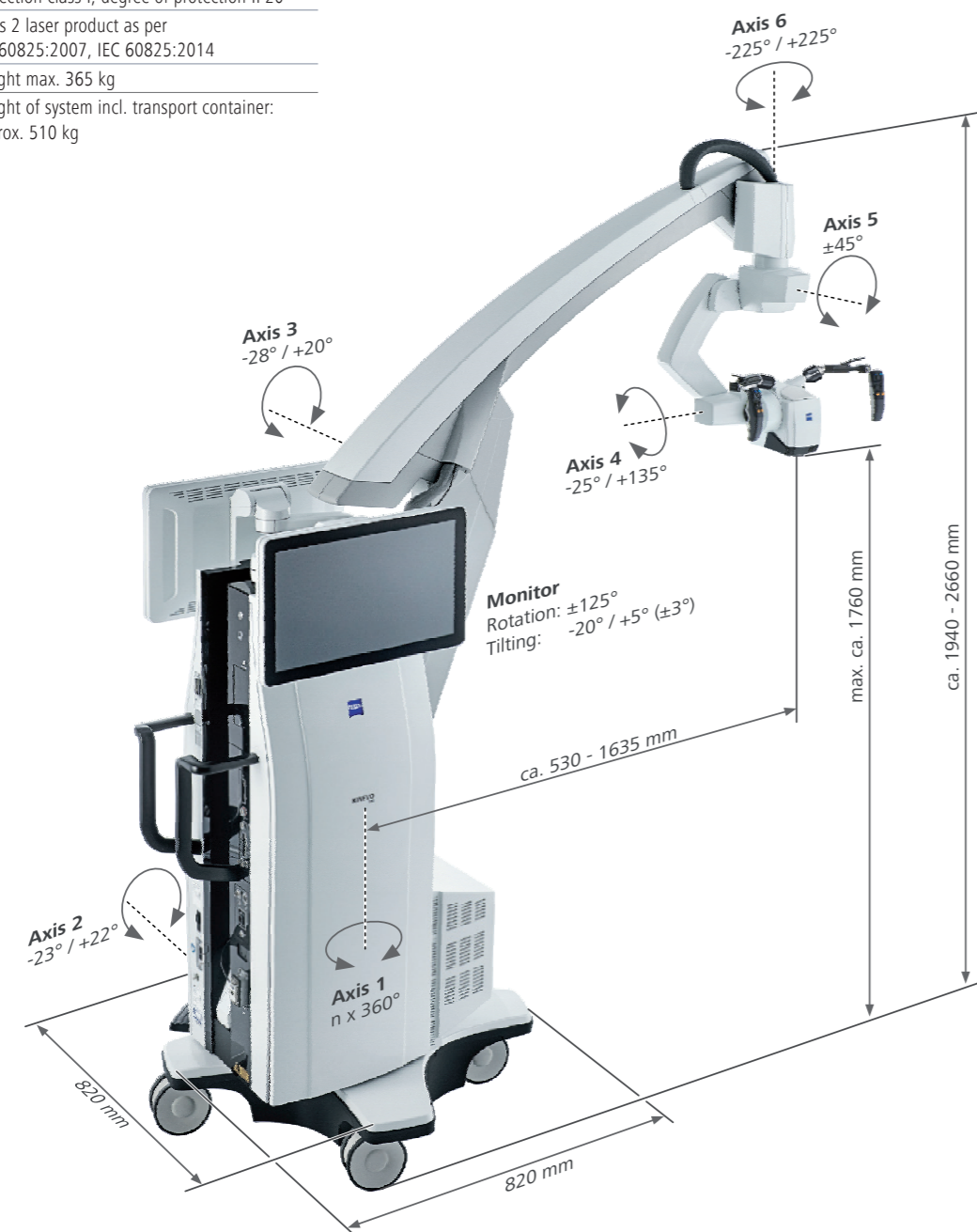

QEVO® from ZEISS and QEVO ECU

Technical Data	
Direction of View	45° upwards
Shaft Diameter	3.6 mm
Shaft Length	120.0 ± 1.0 mm
Total Diameter	13.0 mm
Field of View	100° ± 5° wide angle view
Illumination	20 – 35 lumen LED
Weight (without cable)	250 g
Sterilization	Autoclavable
Image Resolution	1920 x 1080 pixel full HD
Length of Cable	5000 mm
Operation Temperature	+10 to +40 °C (500/1000 s intermittent use)

QEVO ECU	
Dimensions	Length = 265.0 ± 1 mm, height = ± 1 mm and depth = 212.2 ± 1
Weight	2.5 kg
Operating Voltage	24V (+/- 10%) ADC
Video Output	DVI-D full HD



reddot award 2017
winner

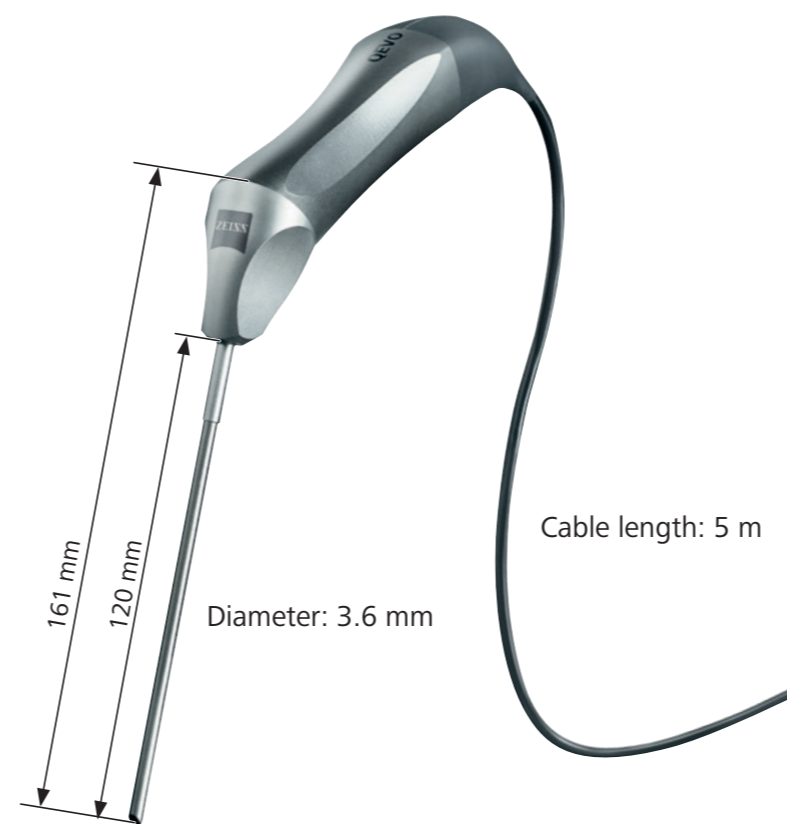

Connecting simplicity and innovation.

ZEISS SMARTDRAPE

Your visualization needs are paramount to us. And, so are the needs of your team. That's why, we gave a special focus to the OR preparation process in the development of ZEISS KINEVO 900.

Being an integral part of the optical path, the SMARTDRAPE® with VisionGuard® from ZEISS is designed together with ZEISS KINEVO 900 so you and your team can have the benefits of a vivid view, uninterrupted movement and effective patient protection. At the same time – the new innovations make the draping process simply simple!

- Innovative folding: to eliminate guesswork and complexity.
- Intuitive attachment: for an effortless and simple self-locking mechanism.
- Integrated RFID chip: for easy activation of AutoDrape®.

Designed for ZEISS KINEVO 900.

Adding even more convenience.

ZEISS OPTIME plus

For added convenience, combine the ZEISS OPTIME plus supplement with your ZEISS service agreement (ZEISS OPTIME prevent, ZEISS OPTIME advanced or ZEISS OPTIME complete).

To keep your operation running smoothly, ZEISS OPTIME plus covers the deliverables of the service package of your choice plus consumables / disposables, which might include:

- Sterile drapes
- Handpieces
- Replacement illumination units
- Others



Technical Data

Standard Configuration

Apochromatic Optics	Motorized focus; Varioskop® with working distance 200 – 625 mm Motorized zoom; zoom ratio 1:6, magnification factor $y = 0.4x - 2.4x$ 10x magnetic wide field eyepieces with integrated eyecups AutoFokus with 2 visible laser dots, automatic mode with magnetic brakes
Illumination	2 x 300 W Xenon, with automatic lamp exchange Automatic Iris Control for adjusting the illumination to the field of view Individual light threshold setting Focus Light Link: working distance controlled light intensity Additional illumination beam to brighten up shadows, motorized
System Operation	Multifunctional programmable handgrips Magnetic clutches for all system axes Central user interface with full-screen video XY robotic movement in 6 axes (variable speed) Active dampening Manual and motorized PointLock function PositionMemory Motorized XY lateral movement
System Setup	AutoBalance AutoDrape – air evacuation system ¹
Video	Integrated 3-chip Full HD video camera, 1080p 24" HD video touchscreen on extendable arm, 16:9 aspect ratio Integrated still image capturing both on HDD and USB-media
Connectivity / Data Management	Video-in for external HD video sources Remote diagnosis via internet / VPN

¹Available with ZEISS SMARTDRAPE only.

Options

Video	Stereo video camera 3D HD, fully integrated, 2x 3-chip HD, 1080p 4K video camera, fully integrated 3-chip 4K, 2160p Stereo video camera 4K 3D, fully integrated, 2 x 3-chip 4K, 2160p Integrated HD video recording and editing Attachment for consumer (SLR) photo camera External 55" 4K 3D video monitor, with mobile cart
Intraoperative Fluorescence	BLUE 400 INFRARED 800 INFRARED 800 with FLOW 800 YELLOW 560
Connectivity / Data Management	DICOM module for image and video data transfer from/to PACS. Patient management by modality worklist management. Shared Network Data storage WLAN option, with WiFi Hotspot Navigation Interface Standard Navigation Interface Extended
Accessories	12.5x magnetic wide field eyepieces with integrated eyecups Stereo co-observation tube Foldable Tube f170 / f260, including the PROMAG function for additional 50% magnification and integrated rotate function Tilttable binocular tube, swivel range 180°, focal length $f = 170$ mm 14-function, wired foot control panel 14-function, wireless foot control panel 2-function foot switch Mouth switch 3-step magnification changer

View of the cerebellar tonsils and medulla. Image courtesy of Dr. Robert F. Spetzler, Barrow Neurological Institute, Phoenix, Arizona, USA. (Cover page)

View onto cerebellum and lower cranial nerves. Image courtesy of Dr. Robert F. Spetzler, Barrow Neurological Institute, Phoenix, Arizona, USA. (Page 2)

Front temporal area for STA-MCA bypass procedure. Image courtesy of Dr. Peter Nakaji, Barrow Neurological Institute, Phoenix, Arizona, USA (Page 2)

View onto optic nerve and internal carotid artery. Image courtesy of Dr. Peter Nakaji, Barrow Neurological Institute, Phoenix, Arizona, USA (Page 4)

Image-guided surgery. Image courtesy of BrainLab AG (Page 6)

Cranial procedure. Image courtesy of Barrow Neurological Institute, Phoenix, Arizona, USA (Page 7)

Small view of the cerebellum through the Retrosigmoid Approach. Image courtesy of Dr. Peter Nakaji, Barrow Neurological Institute, Phoenix, Arizona, USA (Page 8)

Right temporal Craniotomy for AVM. Image courtesy of Dr. Robert F. Spetzler, Barrow Neurological Institute, Phoenix, Arizona, USA (Page 9, 14 and 15)

View onto corpus callosum and septum pellucidum. Image courtesy of Dr. Peter Nakaji, Barrow Neurological Institute, Phoenix, Arizona, USA (Page 10)

Transnasal transsphenoidal for re-exploration and excision of recurrent pituitary Macroadenoma with possible abdominal fat. Image courtesy of Dr. William White, Barrow Neurological Institute, Phoenix, Arizona, USA (Page 11)

View onto spinal cord dura. Image courtesy of Dr. Robert F. Spetzler, Barrow Neurological Institute, Phoenix, Arizona, USA (Page 12-13)

Glioma surgery using BLUE 400. Image courtesy of Prof. Dr. Walter Stummer, University Clinic, Münster, Germany (Page 15)

Left-temporal craniotomy for tumor resection with YELLOW 560. Image Courtesy of Dr. Peter Nakaji, Barrow Neurological Institute, Phoenix, Arizona, USA. (Page 15)



KINEVO 900
QEVO ECU



0297
QEVO
INFRARED 800 with FLOW 800 option
SMARTDRAPE



Carl Zeiss Meditec AG
Goeschwitzer Strasse 51–52
07745 Jena
Germany
www.zeiss.com/med
www.zeiss.com/kinevo

SUR. 8733 Printed in the United States. CZ-III/2017
The contents of the brochure may differ from the current status of approval of the product or service offering in your country. Please contact our regional representatives for more information.
Subject to changes in design and scope of delivery and due to ongoing technical development. Robotic Visualization System, KINEVO, QEVO, SMARTDRAPE, FLOW, AutoDrape, Varioskop and VisionGuard are either trademarks or registered trademarks of Carl Zeiss Meditec AG.
© Carl Zeiss Meditec AG, 2017. All rights reserved.